



Setare Sepehr Nikan
(JSC)

www.ssndates.com



1:1
Real Size

Piarom
Date

Piarom

Date

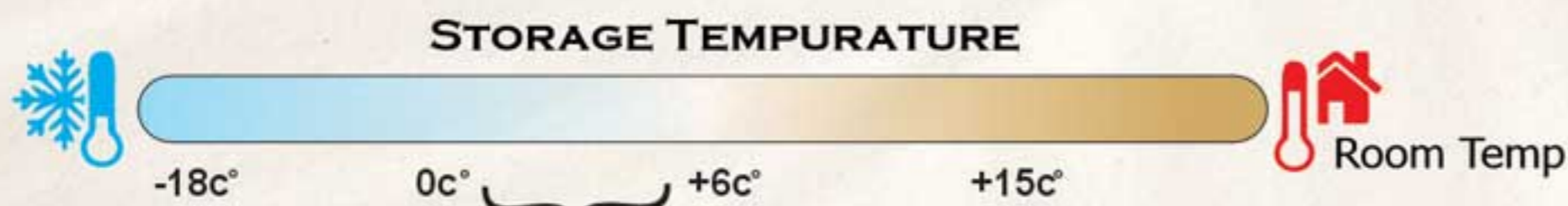

Usually, keeping the product in a temperature range of 4°C (±3) will extend the product's life up to 2 years.

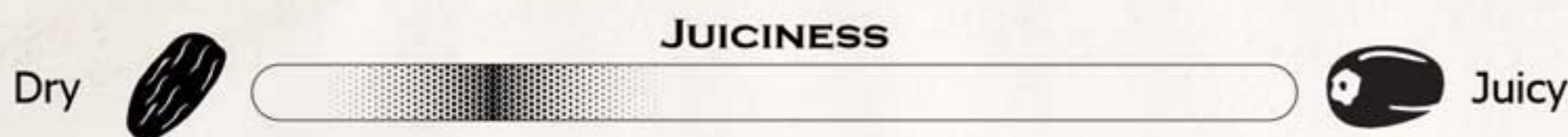

Box Styles

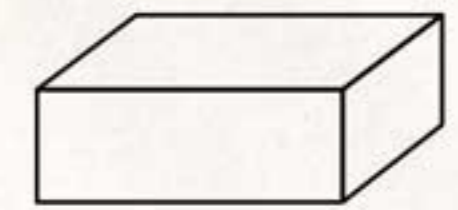
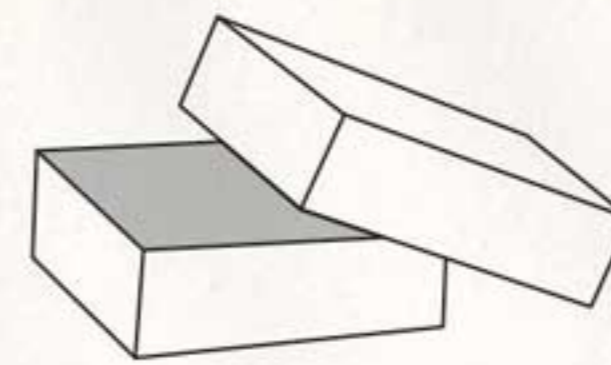

5/7/9 KG
Net Weight

GOLDEN

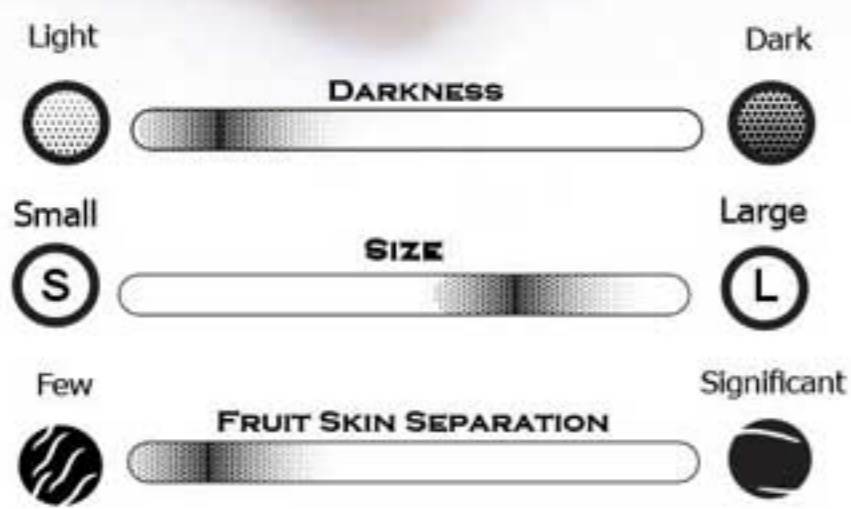

SELECT (AA)

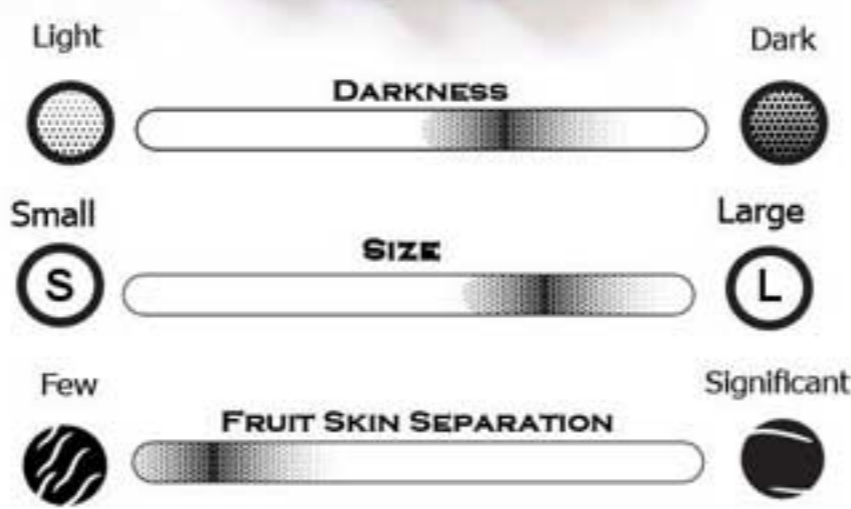

MINI

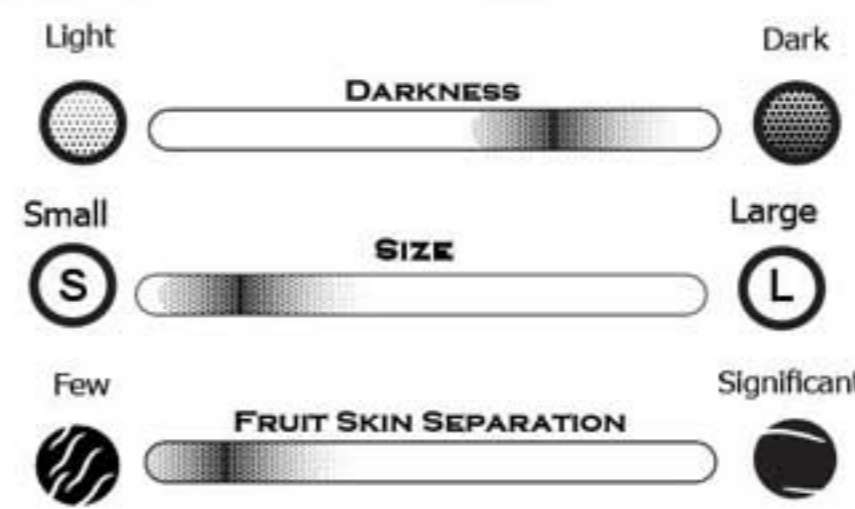

NORMAL

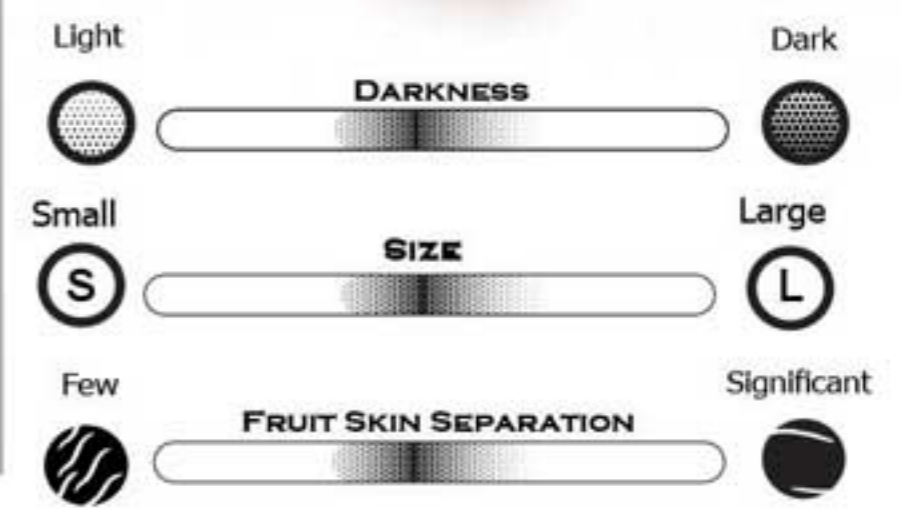

DRY CNTR

MOQ: Bam 5 MT EXW

IR Border Min order 1 Container

Multi Type Order Max (5 types) in 1 Container

Private Labeling is possible and subject to negotiation.



Setare Sepehr Nikan (JSC)
www.ssndates.com



Real Size

Mazafati

Date

"Kimia"

Mazafati

Date

"Kimia"

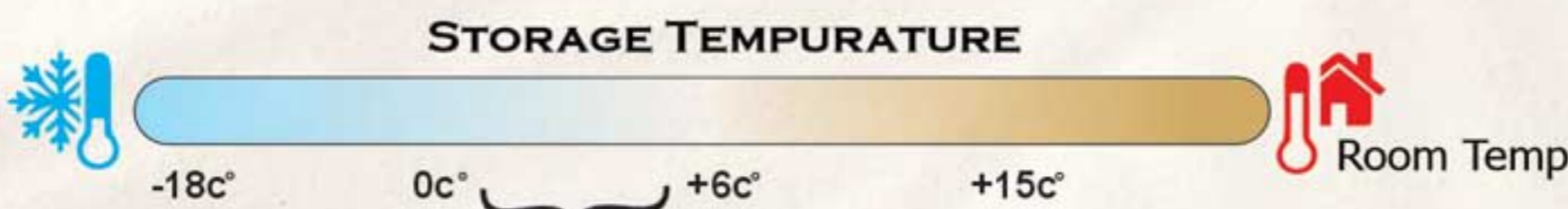

Usually, keeping the product in a temperature range of 4°C (±3) will extend the product's life up to 1 years.

Box Styles

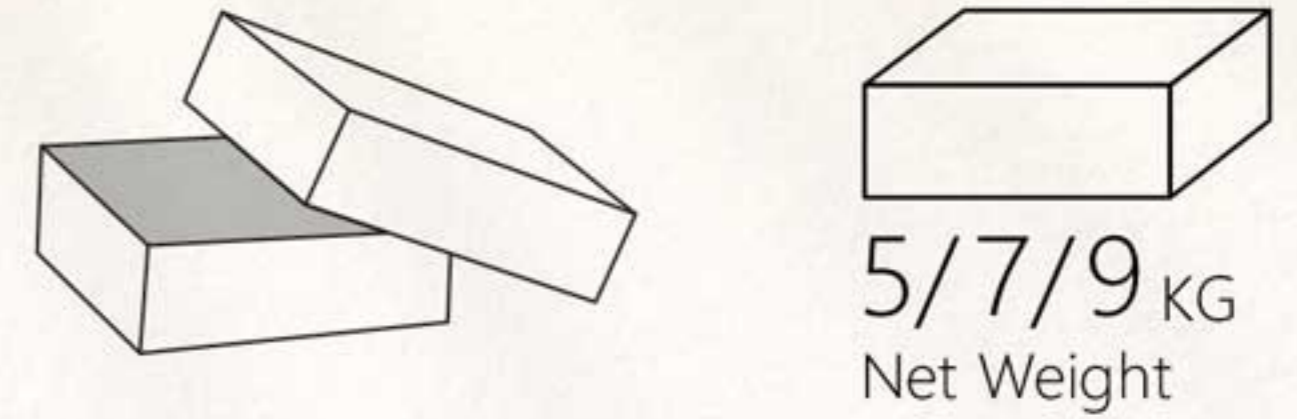
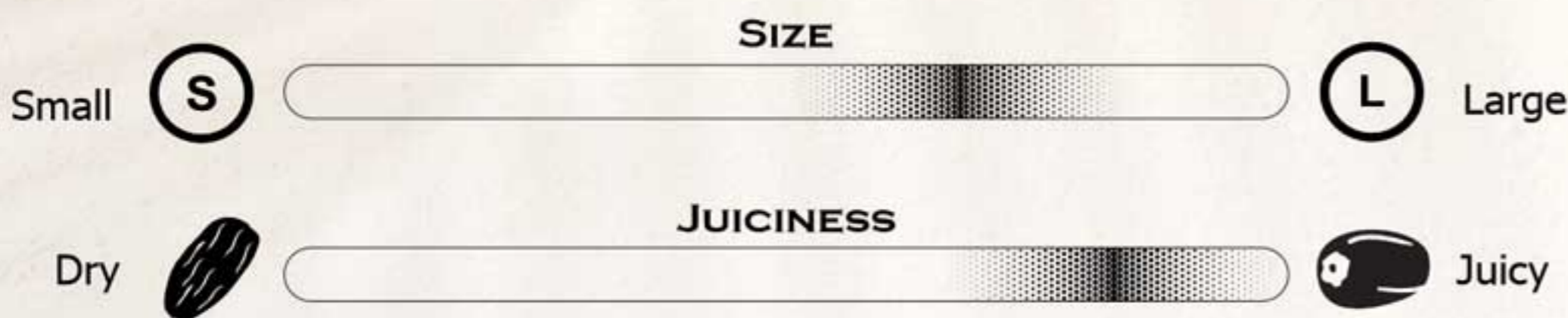

PREMIUM



RF CNTR

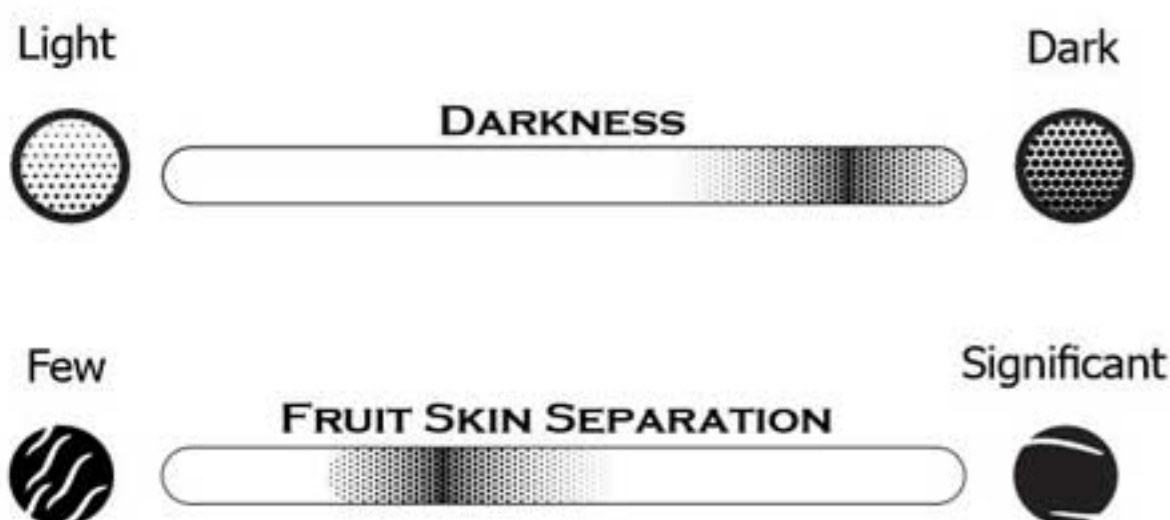

SELECT



RF CNTR

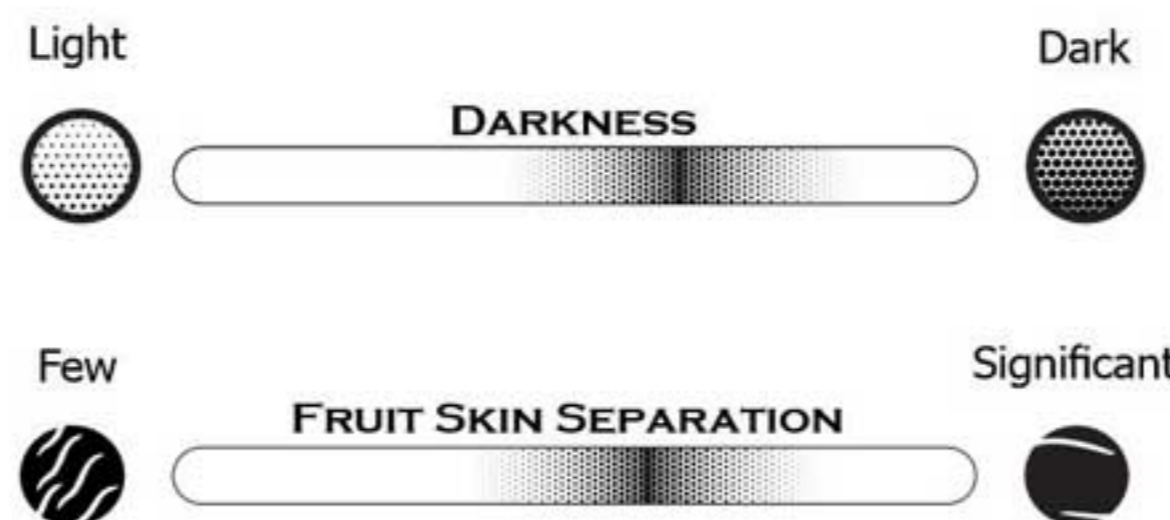

NORMAL



DRY CNTR

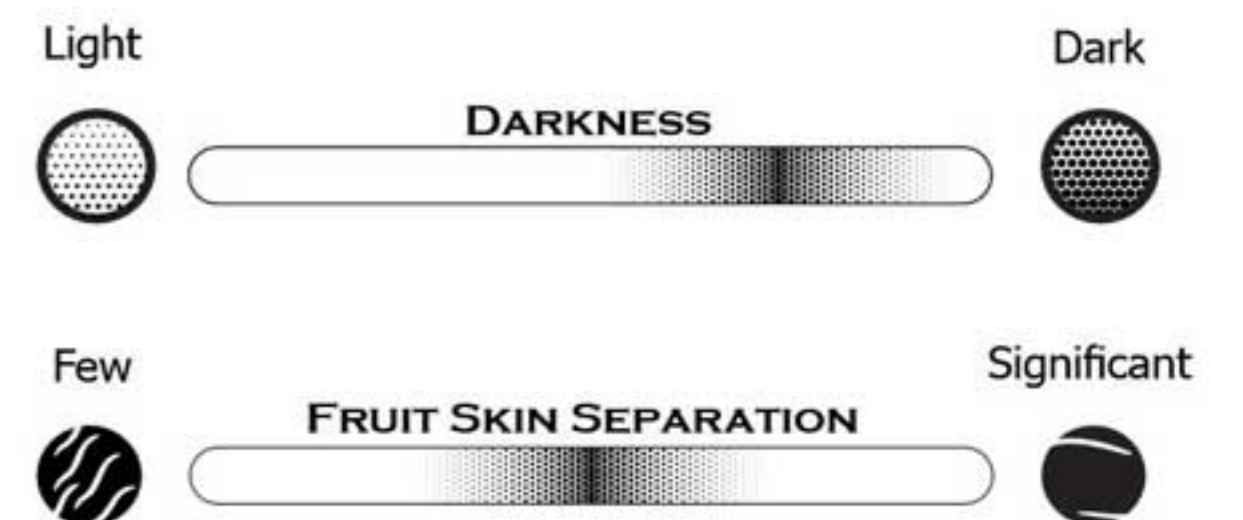

MOQ: Bam 5 MT EXW

IR Border Min order 1 Container

Multi Type Order Max (5 types) in 1 Container

Private Labeling is possible and subject to negotiation.



Real Size

Gantar

Date

Gantar

Date

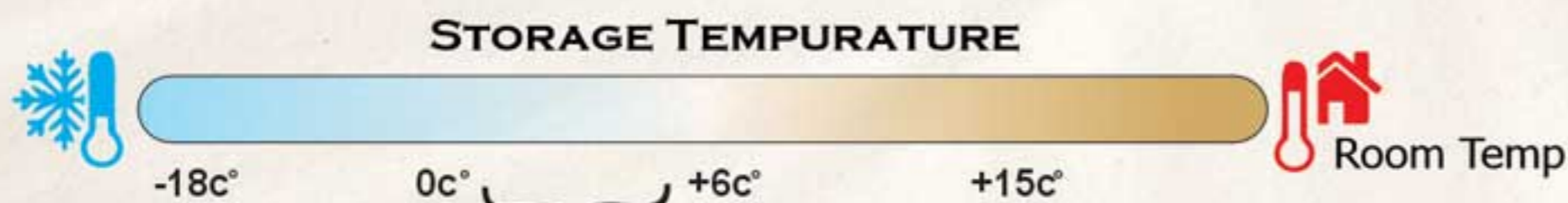

Usually, keeping the product in a temperature range of 4°C (±3) will extend the product's life up to 2 years.

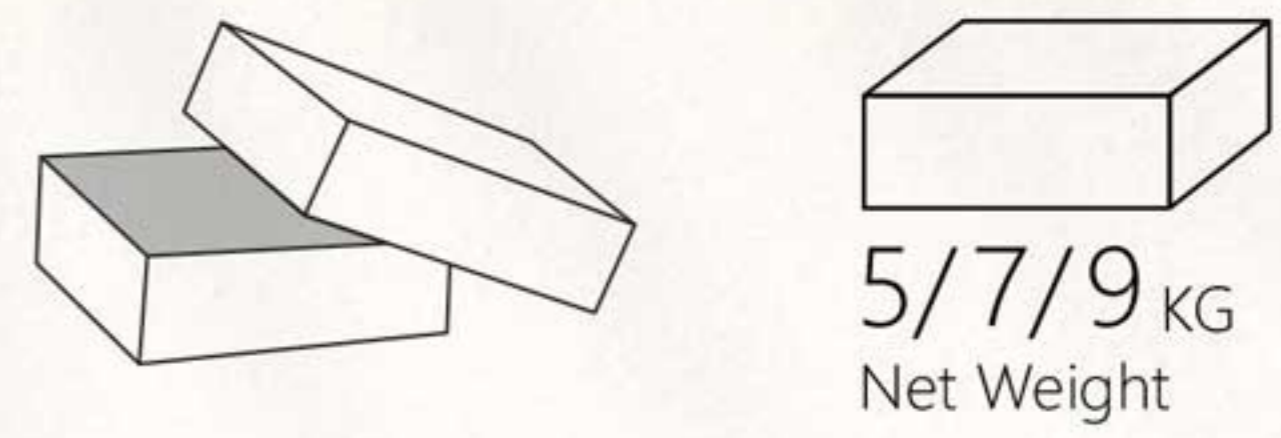
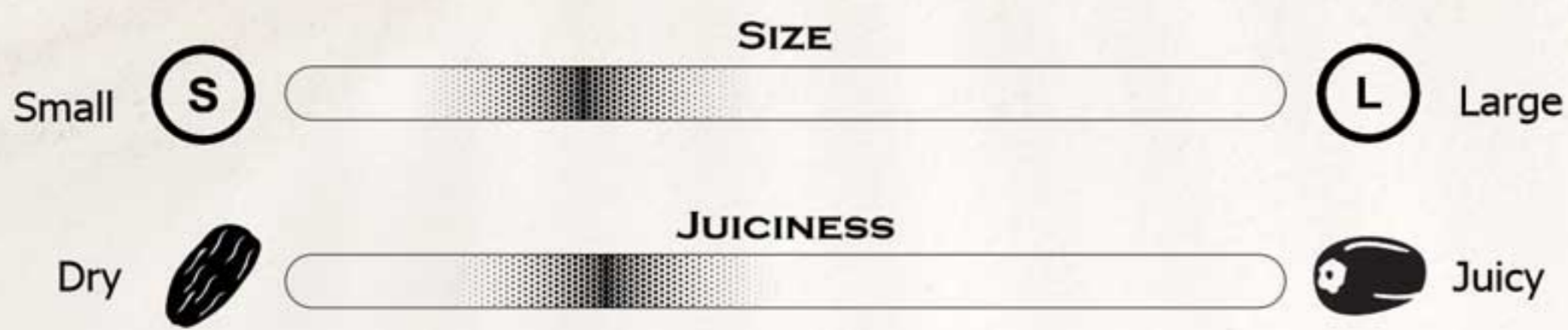

Box Styles

PREMIUM

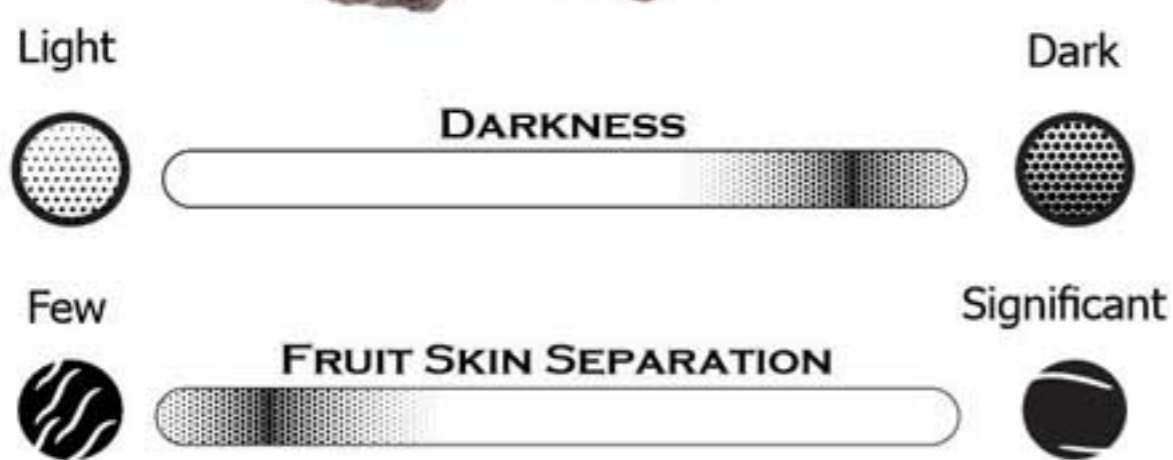

SELECT

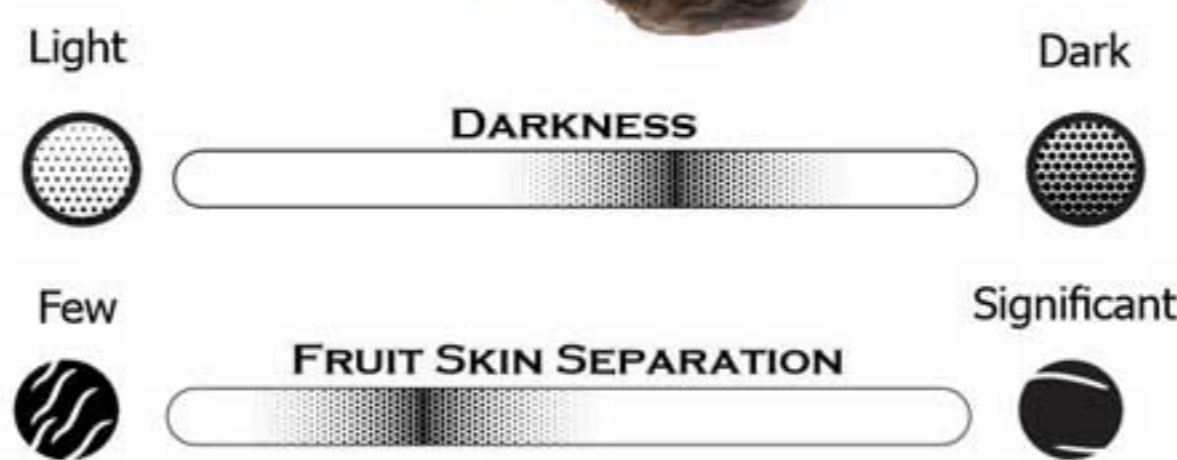

NORMAL

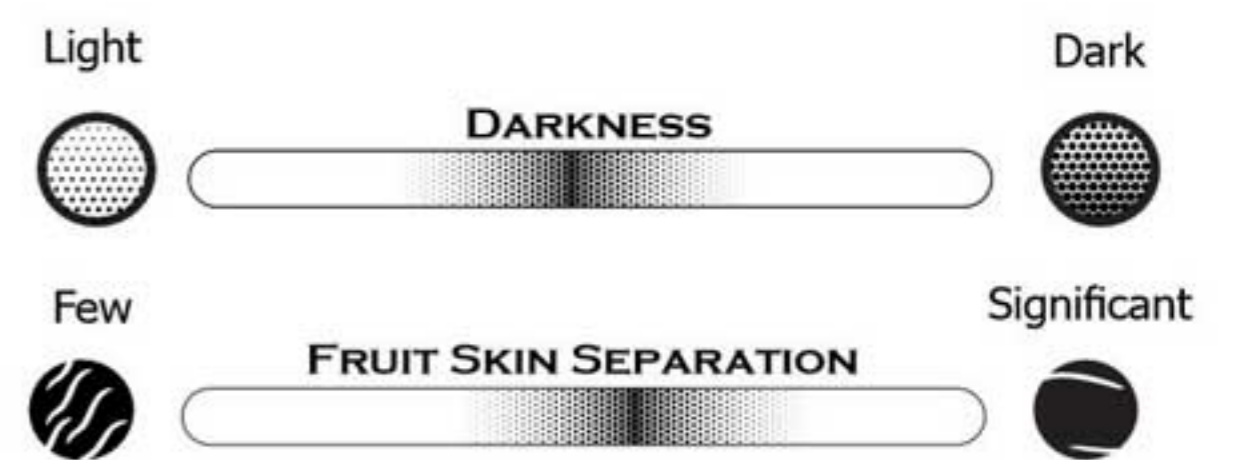

DRY CNTR

MOQ: Bam 5 MT EXW

IR Border Min order 1 Container

Multi Type Order Max (5 types) in 1 Container

Private Labeling is possible and subject to negotiation.



Setare Sepehr Nikan (JSC)
www.ssndates.com



Real Size

Khasuei

Date

Khasuei

Date

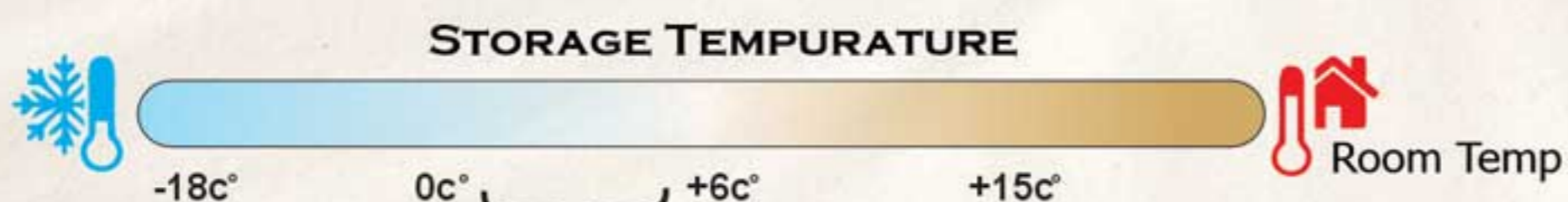

Usually, keeping the product in a temperature range of 4°C (±3) will extend the product's life up to 2 years.

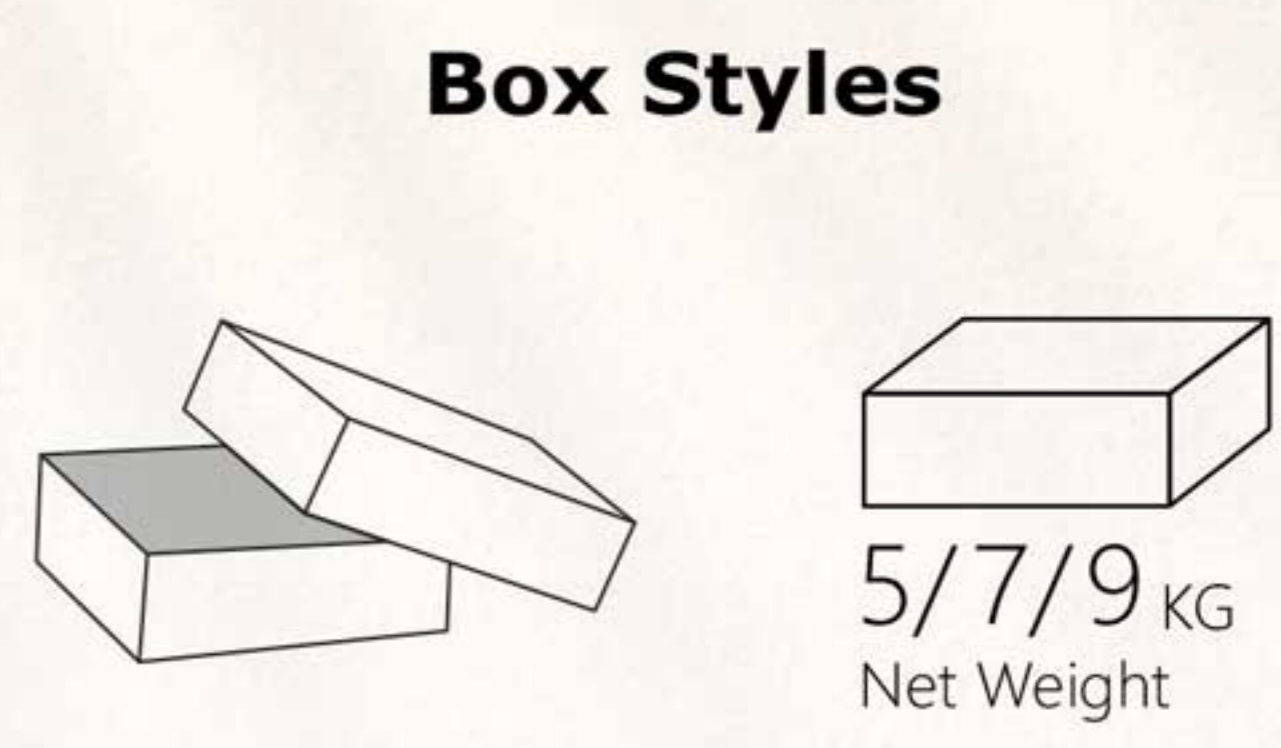

PREMIUM

SELECT

NORMAL

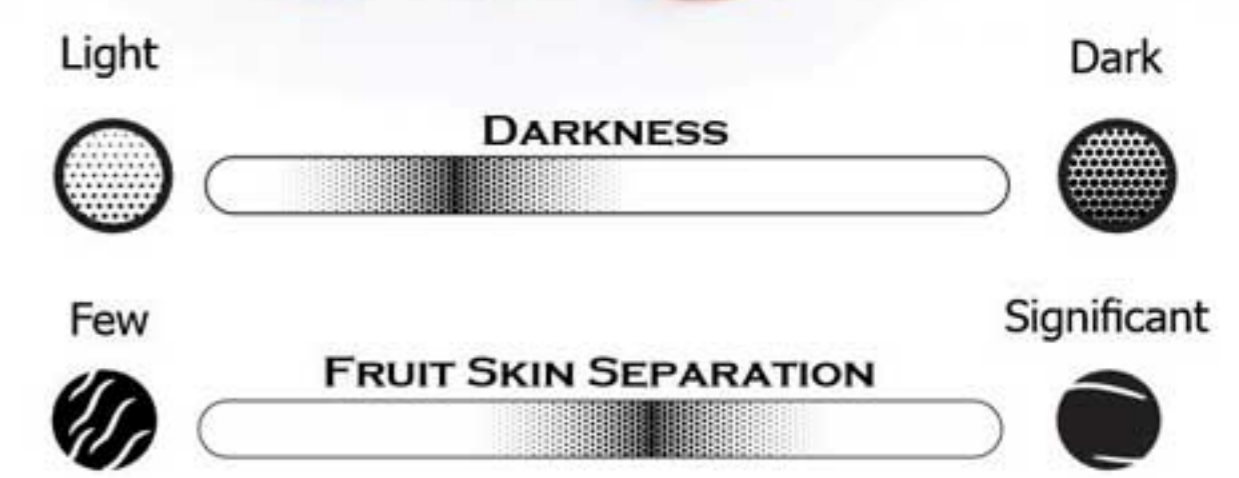

DRY CNTR

MOQ: Bam 5 MT EXW

IR Border Min order 1 Container

Multi Type Order Max (5 types) in 1 Container

Private Labeling is possible and subject to negotiation.



1:1
Real Size

Rabbi
Date

Rabbi

Date

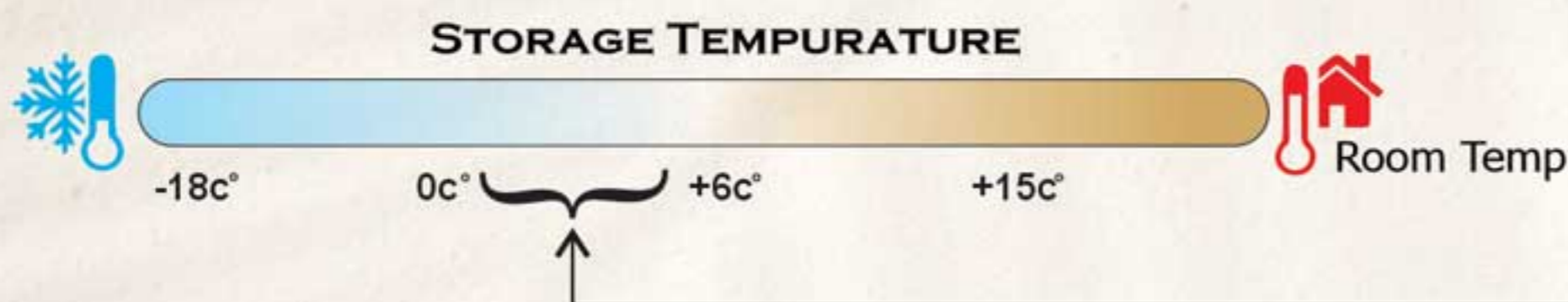

● Usually, keeping the product in a temperature range of 4°C (±3) will extend the product's life up to 2 years.

Dry		JUICINESS		Juicy
Small	S	SIZE	L	Large
Light		DARKNESS		Dark
Few		FRUIT SKIN SEPARATION		Significant



Box Styles

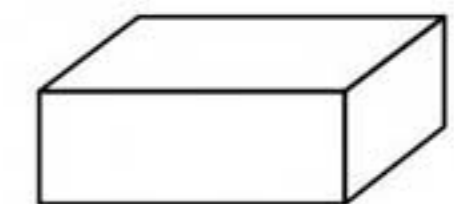
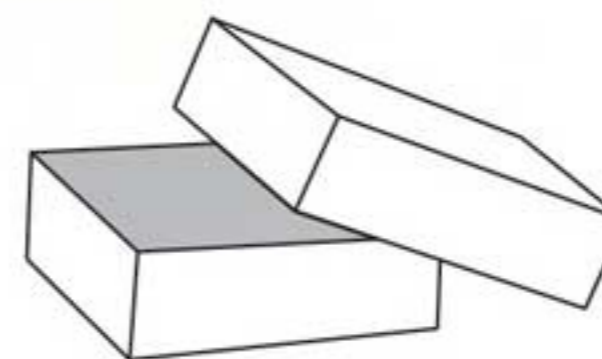

5/7/9 KG
Net Weight

DRY CNTR

MOQ: Bam 5 MT EXW

IR Border Min order 1 Container

Multi Type Order
Max (5 types) in 1 Container

Private Labeling is possible and subject to negotiation.



Setare Sepehr Nikan (JSC)
www.ssndates.com



1:1
Real Size

Zahedi
Date

Zahedi

Date

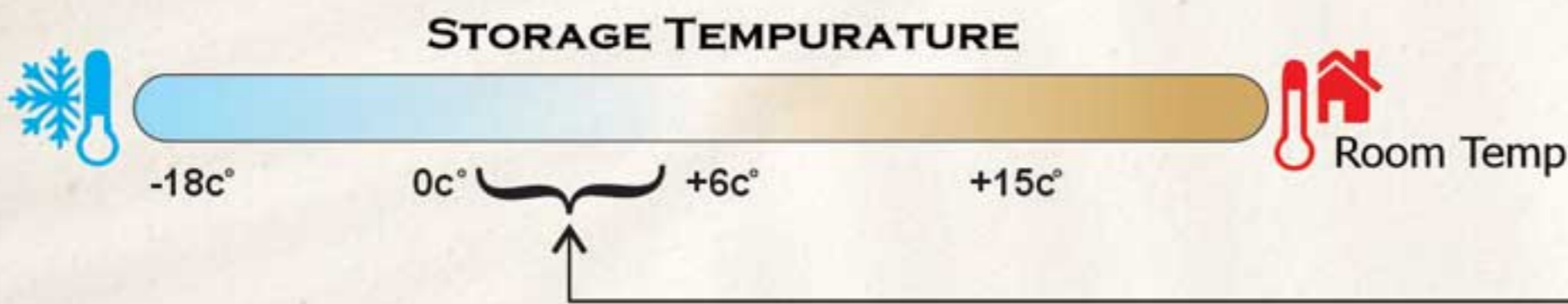

● Usually, keeping the product in a temperature range of 4°C (±3) will extend the product's life up to 2 years.

Dry		JUICINESS		Juicy
Small	S	SIZE	L	Large
Light		DARKNESS		Dark
Few		FRUIT SKIN SEPARATION		Significant



Box Styles

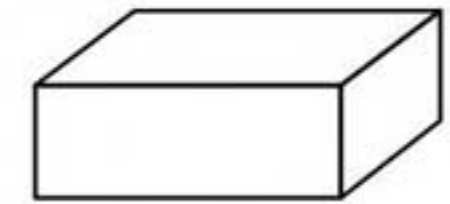
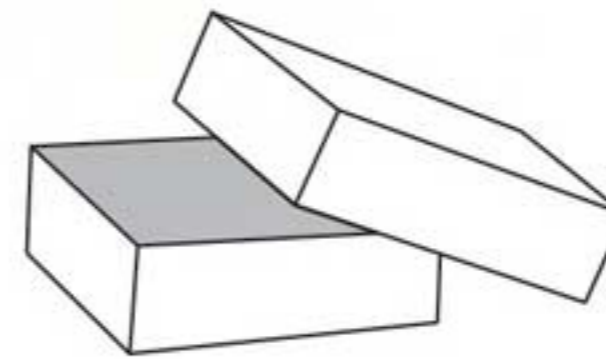

5/7/9 KG
Net Weight

DRY CNTR

MOQ: Bam 5 MT EXW

IR Border Min order 1 Container

Multi Type Order
Max (5 types) in 1 Container

Private Labeling is possible and subject to negotiation.



Setare Sepehr Nikan (JSC)
www.ssndates.com



Real Size

Kabkab

Date

Kabkab

Date

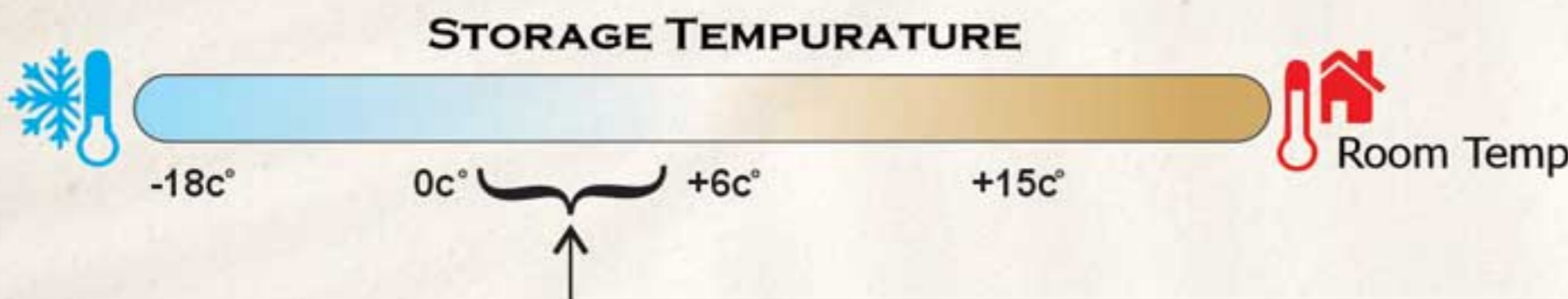

● Usually, keeping the product in a temperature range of 4°C (±3) will extend the product's life up to 2 years.

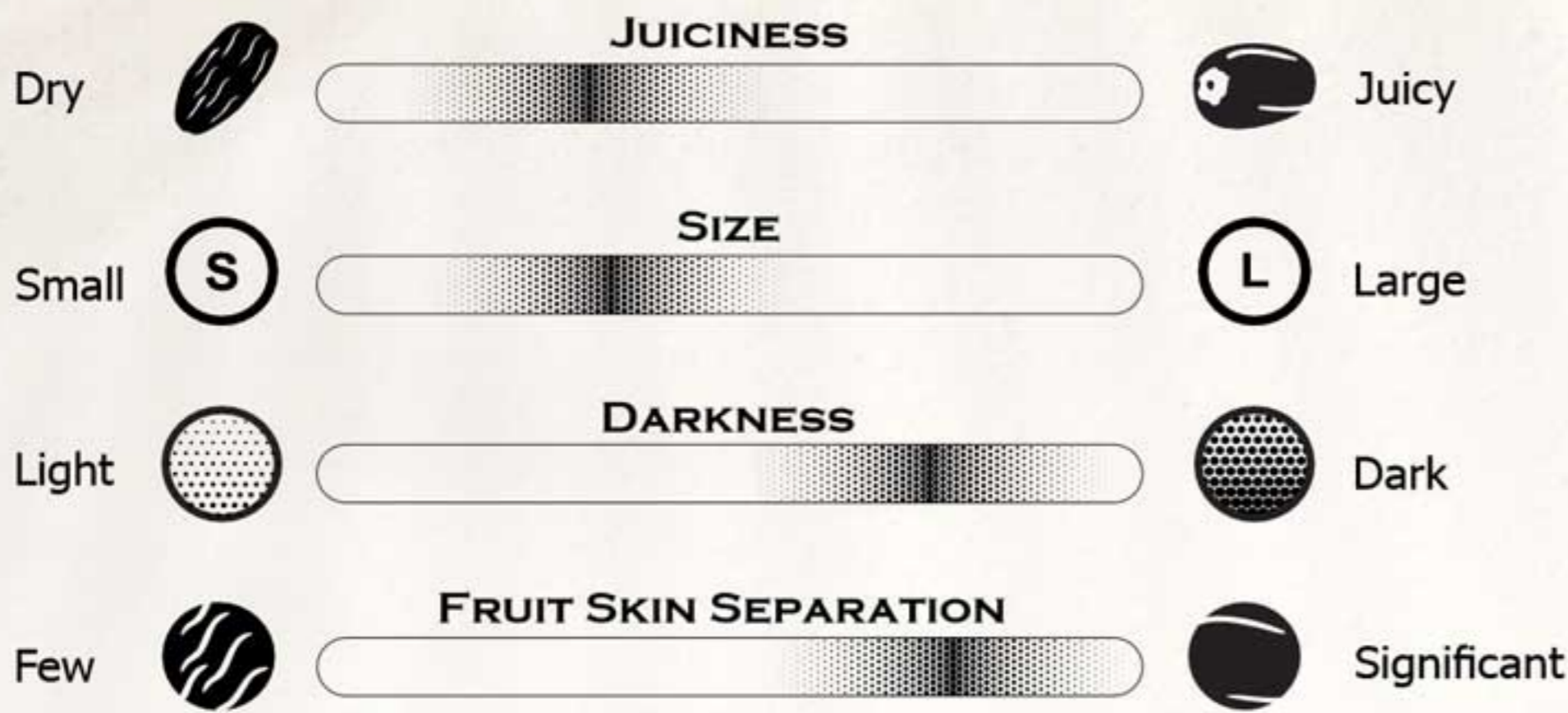

Box Styles

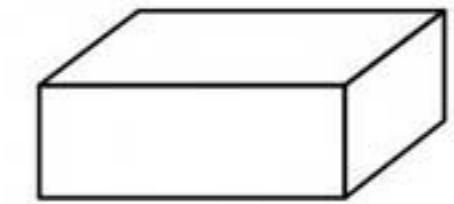
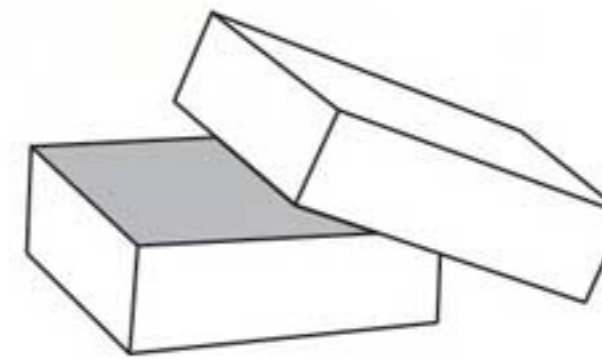

5/7/9 KG
Net Weight

DRY CNTR

MOQ: Bam 5 MT EXW

IR Border Min order 1 Container

Multi Type Order
Max (5 types) in 1 Container

Private Labeling is possible and subject to negotiation.



Setare Sepehr Nikan (JSC)
www.ssndates.com



1:1
Real Size

Shahani
Date

Shahani

Date

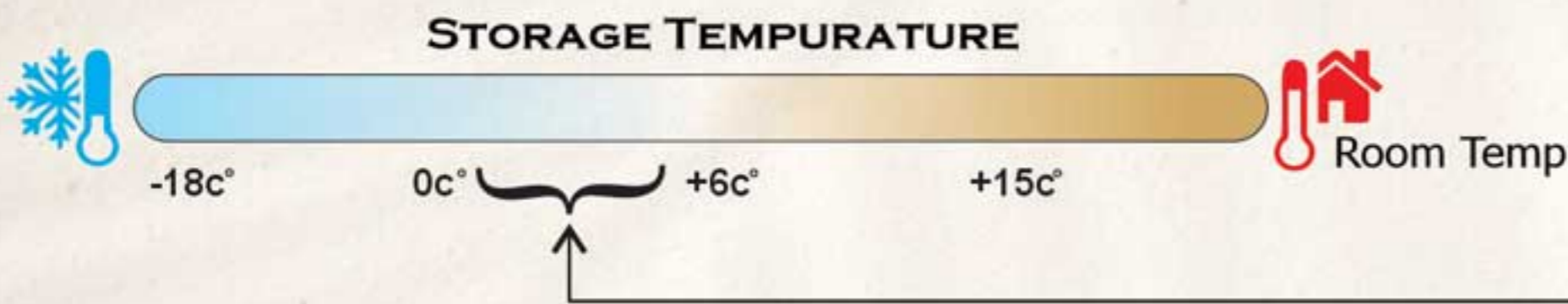

● Usually, keeping the product in a temperature range of 4°C (±3) will extend the product's life up to 2 years.

Dry		JUICINESS		Juicy
Small		SIZE		Large
Light		DARKNESS		Dark
Few		FRUIT SKIN SEPARATION		Significant



Box Styles

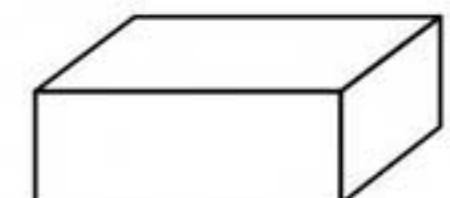
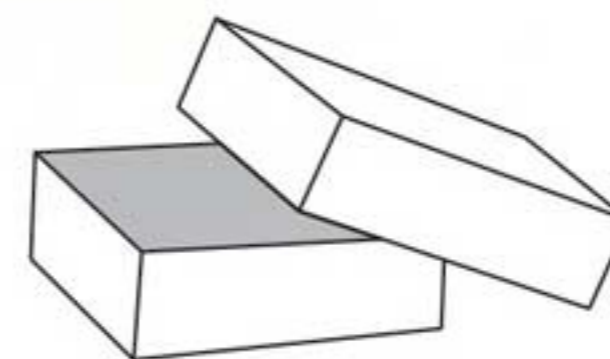

5/7/9 KG
Net Weight

DRY CNTR

MOQ: Bam 5 MT EXW

IR Border Min order 1 Container

Multi Type Order
Max (5 types) in 1 Container

Private Labeling is possible and subject to negotiation.



Real Size

Khenizi

Date

Khenizi

Date

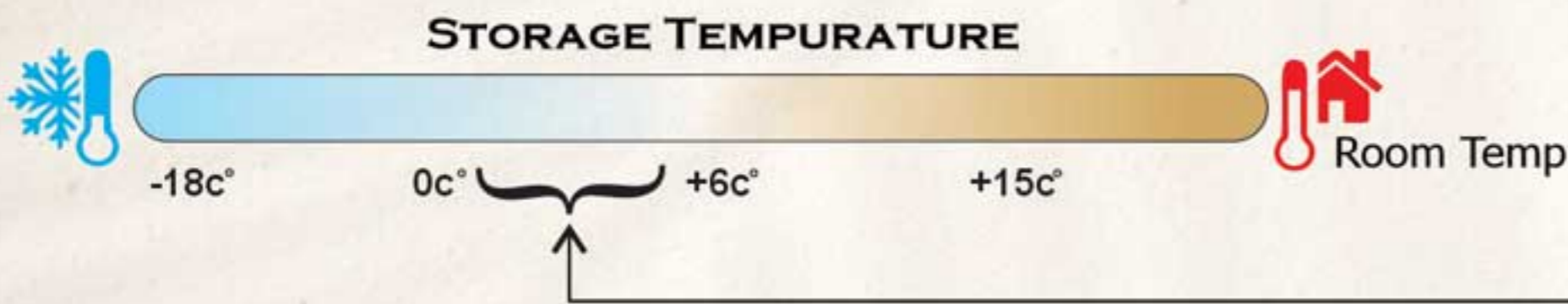

● Usually, keeping the product in a temperature range of 4°C (±3) will extend the product's life up to 2 years.

Dry		JUICINESS			Juicy
Small	S	SIZE		L	Large
Light		DARKNESS			Dark
Few		FRUIT SKIN SEPARATION			Significant



Box Styles

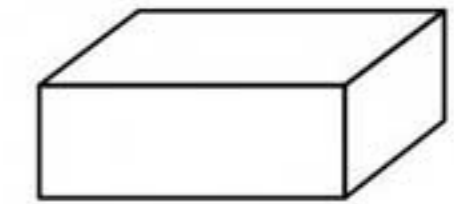
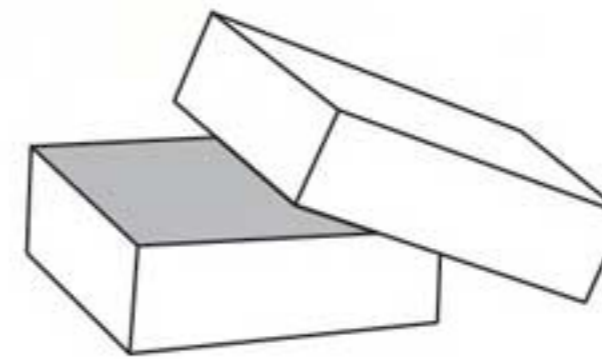

5/7/9 KG
Net Weight

DRY CNTR

MOQ: Bam 5 MT EXW

IR Border Min order 1 Container

Multi Type Order
Max (5 types) in 1 Container

Private Labeling is possible and subject to negotiation.



Setare Sepehr Nikan (JSC)
www.ssndates.com



Real Size

Kalouteh

Date

Kalouteh

Date

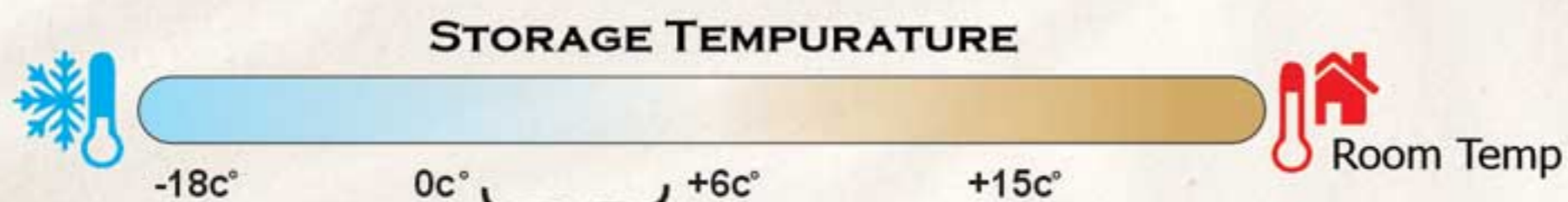

Usually, keeping the product in a temperature range of 4°C (±3) will extend the product's life up to 2 years.

Box Styles

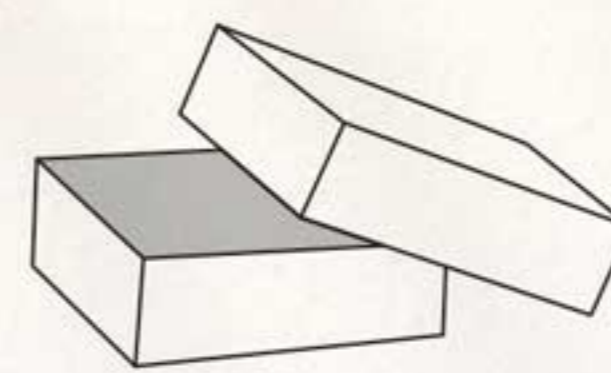

NORMAL

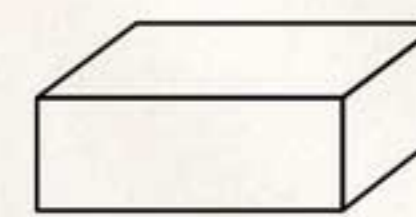

5/7/9 KG
Net Weight

SELECT

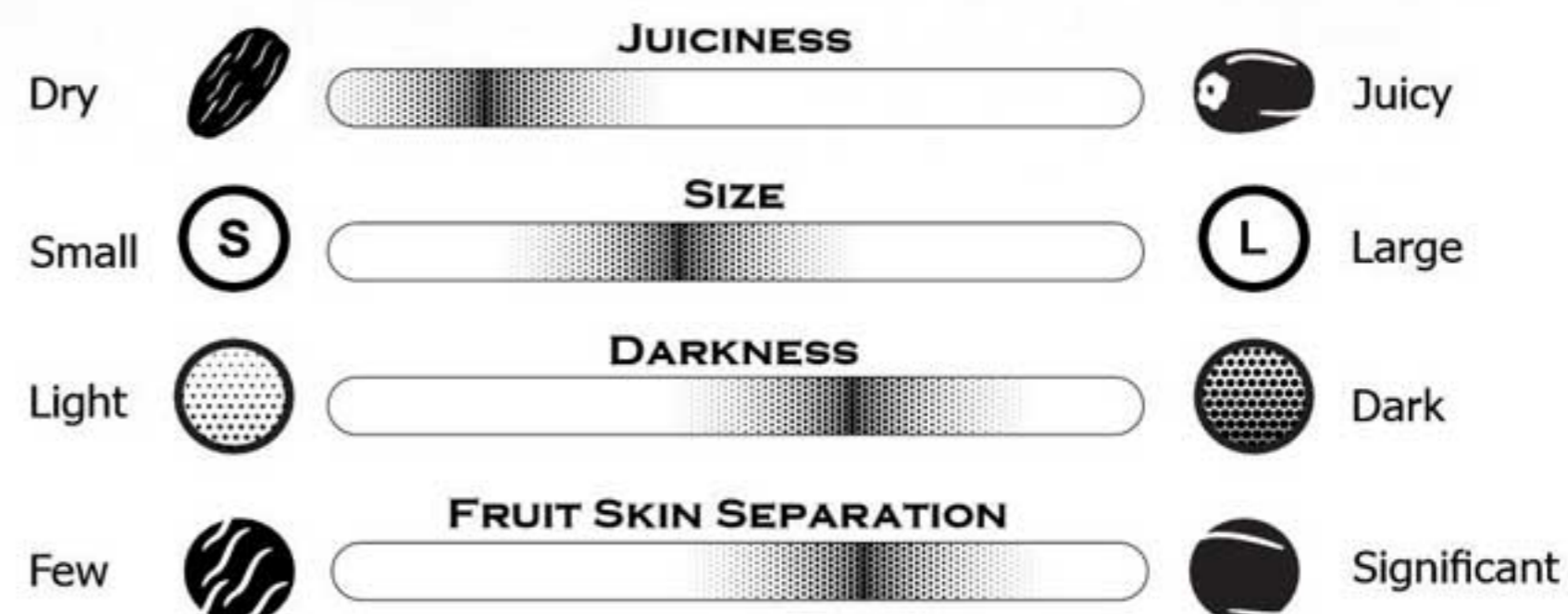
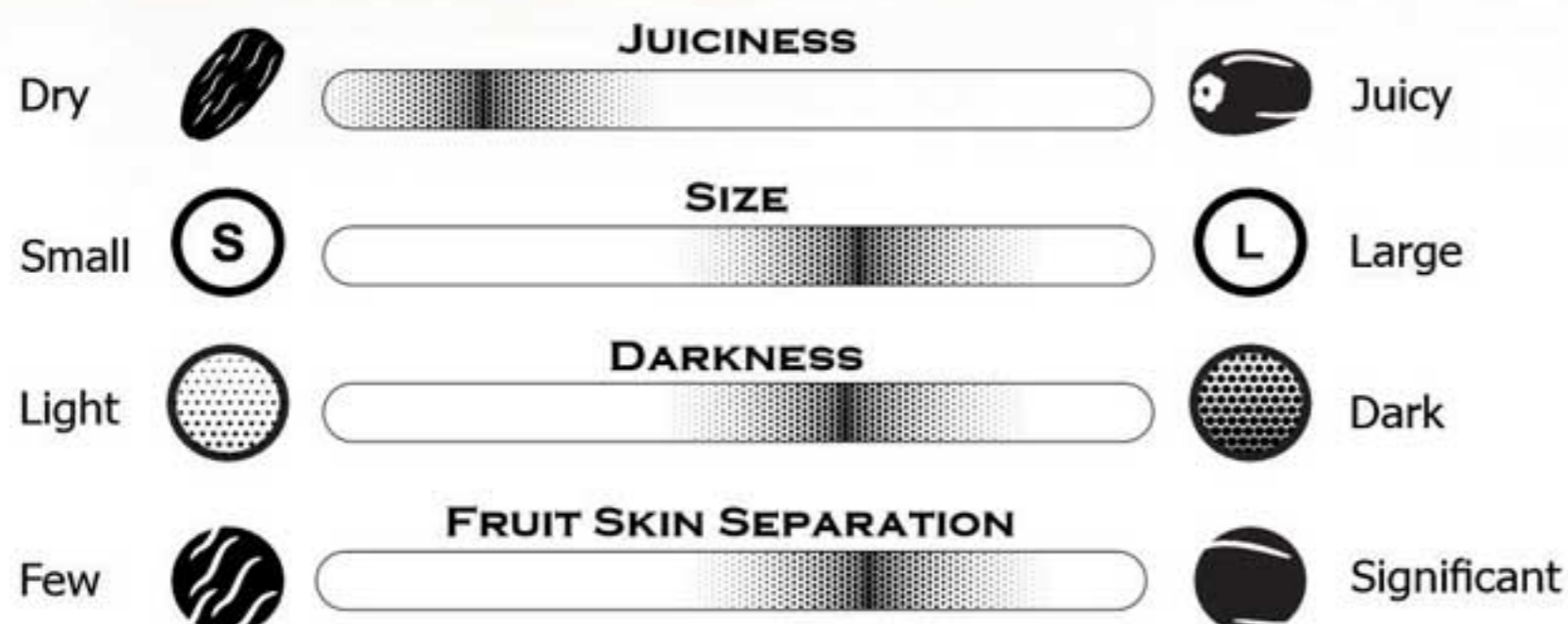

DRY CNTR

MOQ: Bam 5 MT EXW

IR Border Min order 1 Container

Multi Type Order Max (5 types) in 1 Container

Private Labeling is possible and subject to negotiation.



Setare Sepehr Nikan (JSC)
www.ssndates.com



Real Size

Farakan

Date

Farakan

Date

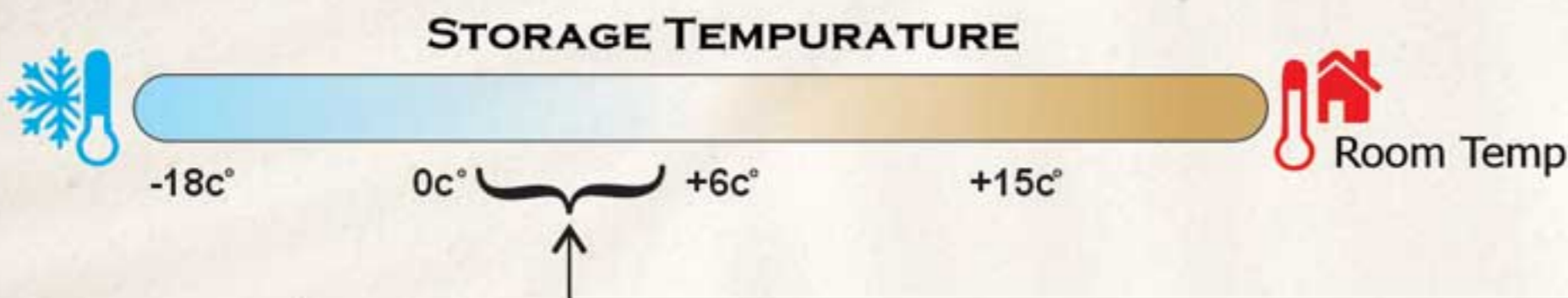

● Usually, keeping the product in a temperature range of 4°C (±3) will extend the product's life up to 2 years.

Dry		JUICINESS			Juicy
Small	S	SIZE		L	Large
Light		DARKNESS			Dark
Few		FRUIT SKIN SEPARATION			Significant



Box Styles

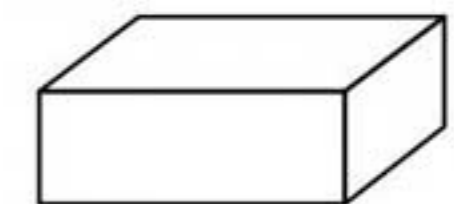
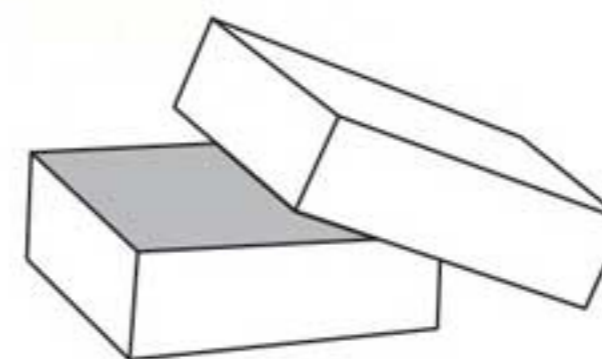

5/7/9 KG
Net Weight

DRY CNTR

MOQ: Bam 5 MT EXW

IR Border Min order 1 Container

Multi Type Order
Max (5 types) in 1 Container

Private Labeling is possible and subject to negotiation.



Setare Sepehr Nikan (JSC)
www.ssndates.com





Real Size

Shahabi
Date

Shahabi

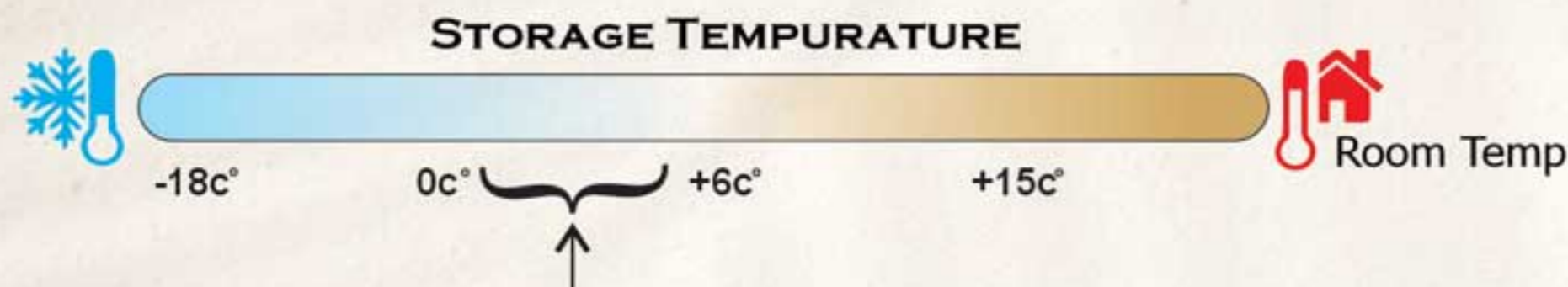
Date



● Usually, keeping the product in a temperature range of 4°C (±3) will extend the product's life up to 2 years.

JUICINESS

Dry Juicy

SIZE

Small Large

DARKNESS

Light Dark

FRUIT SKIN SEPARATION

Few Significant



Box Styles

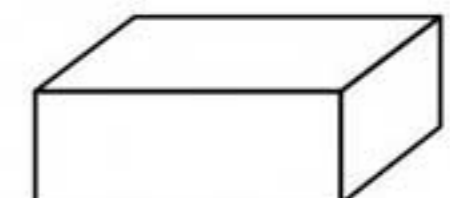
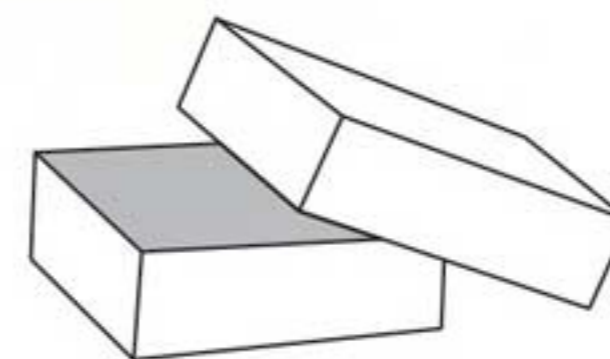

5/7/9 KG
Net Weight

DRY CNTR

MOQ: Bam 5 MT EXW

IR Border Min order 1 Container

Multi Type Order
Max (5 types) in 1 Container

Private Labeling is possible and subject to negotiation.



1:1
Real Size

Sayer
Date

Sayer

Date

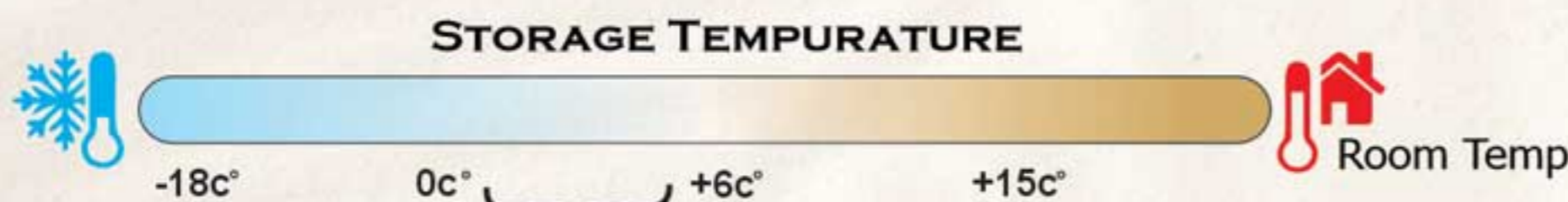

Usually, keeping the product in a temperature range of 4°C (±3) will extend the product's life up to 2 years.

Box Styles

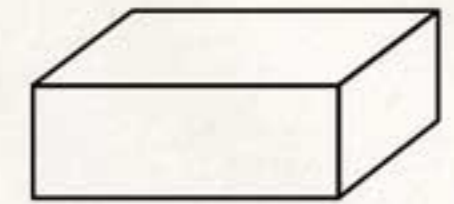
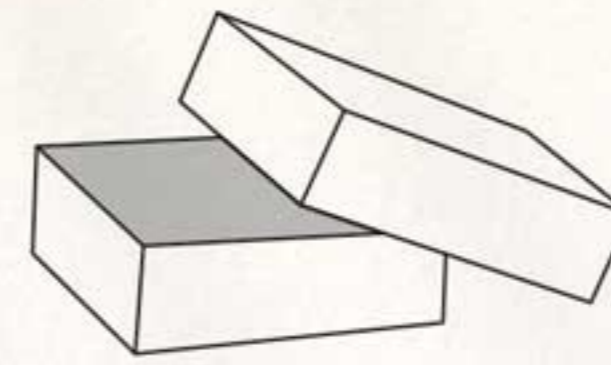

5/7/9 KG
Net Weight

SELECT



Pitted & Un Pitted

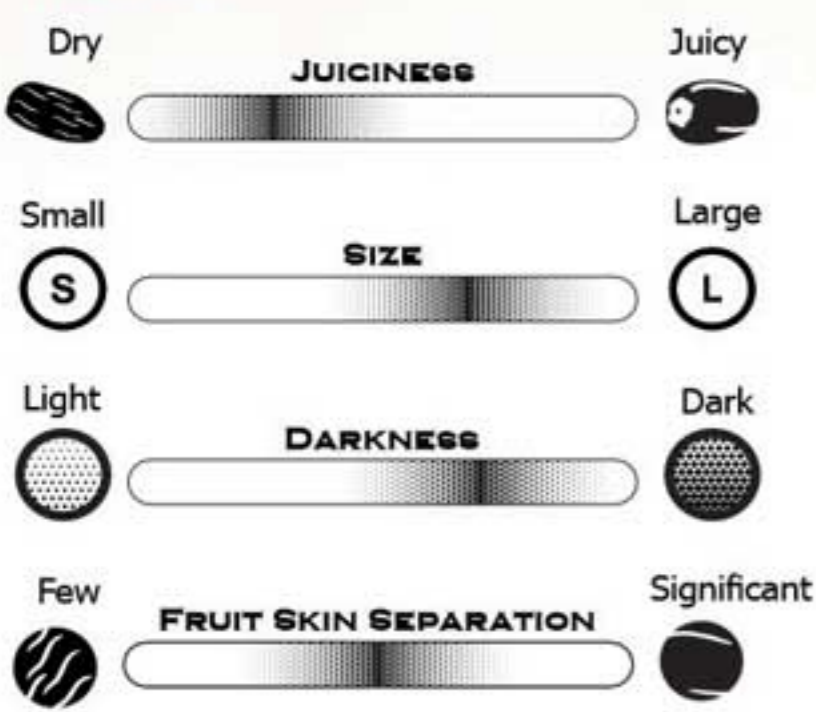

B GRADE



Pitted & Un Pitted

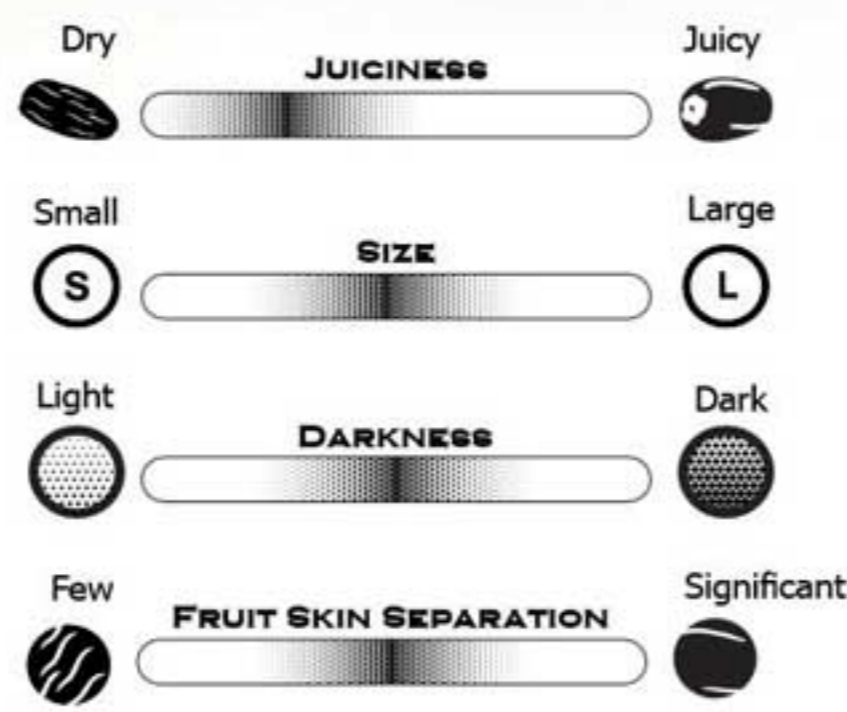

GAQ



Pitted & Un Pitted

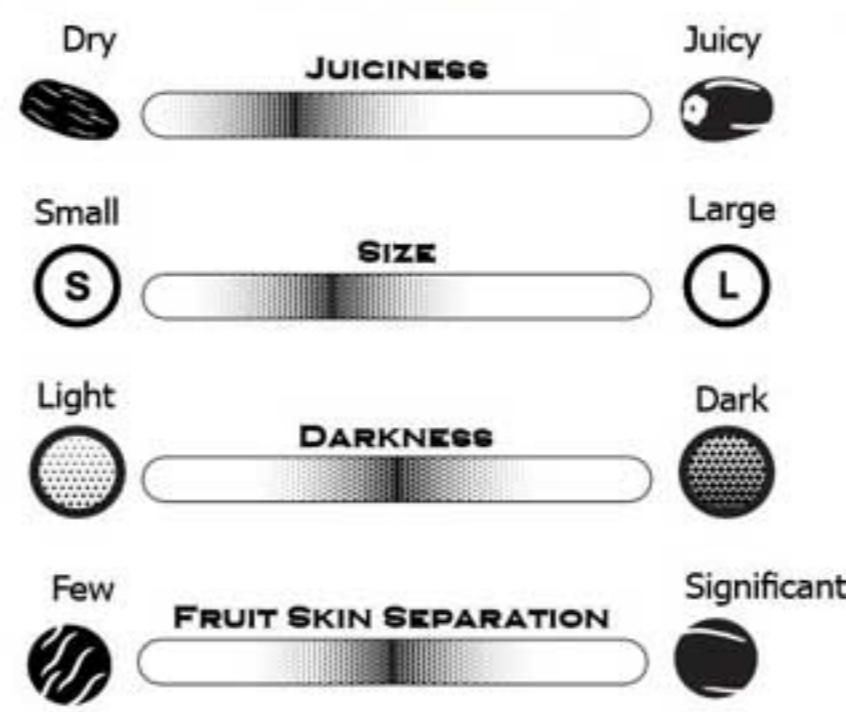

FAQ



Pitted & Un Pitted

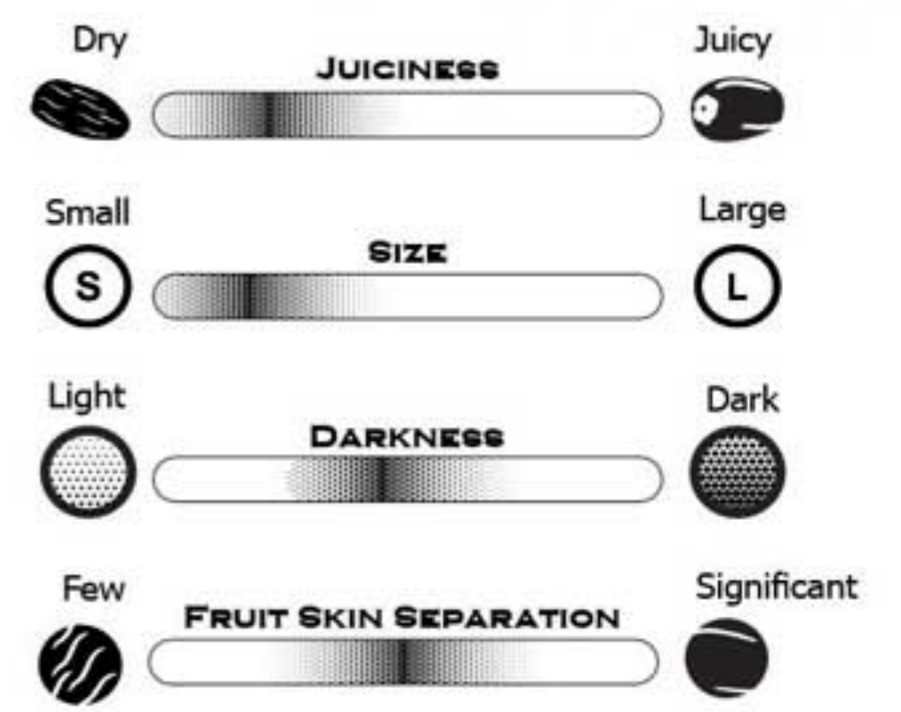

DRY CNTR

MOQ: Bam  5 MT EXW

IR Border  Min order 1 Container

 Multi Type Order
Max (5 types) in 1 Container

Private Labeling is possible and subject to negotiation.



Setare Sepehr Nikan (JSC)
www.ssndates.com



SSN Dates, is a part of food industry, that tries to produce foods such as dates with the highest quality by using a suitable process and high accuracy

Products

ROTAB

Physiological growth stage of palm fruit that has soft, delicate and full of nectar.

DATE

The final stage of physiological development of palm fruit.

Classification of date by type

Dried Dates

- It refers to a ripe date which the moisture is below 18%.

Semi Dried Dates

- It refers to a ripe date with the moisture between 18% and 20%.

Soft Dates

- It refers to a ripe date with the moisture between 20% and 23%.

Rotab

- It refers to a ripe and juicy date, which the moisture is between 23% and 38%.



Catalog

